



USERS MANUAL

MASTERLINK MICC

MASS INVERTER CHARGER CONTROL



MASTERVOLT
Snijdersbergweg 93,
1105 AN Amsterdam
The Netherlands
Tel.: +31-20-3422100
Fax.: +31-20-6971006
www.mastervolt.com

Language	: English
Version	: V4.0-301104

CONTENTS

V4.0 November 2004

1	GENERAL INFORMATION	5
1.1	Use of this manual	5
1.2	Guarantee Specifications	5
1.3	Quality	5
1.4	Validity of this manual	5
1.5	Liability	5
2	SAFETY GUIDELINES & MEASURES	6
2.1	Warnings and symbols	6
2.2	Use for intended purpose	6
2.3	Organisational measures	6
2.4	Warning for special dangers	6
3	INSTALLATION	7
3.1	Tools and equipment required	7
3.2	Materials needed for installation	7
3.3	Step by Step installation	8
3.4	Installation of an external alarm	10
3.5	Connection of the charger and the inverter	10
4	SYNCHRONISATION AND SETTING THE BATTERY CAPACITY	12
4.1	Synchronisation	12
4.2	Setting the battery capacity	12
4.3	Setting the battery voltage	12
4.4	Activate Mass Combi setting	13
4.5	In case you are lost	13
5	OPERATION	14
5.1	General	14
5.2	Remote control of the battery charger	14
5.3	Adjustment of the maximum charge current	15
5.4	Adjustment of the Power sharing / Power support level (Mass Combi only)	15
5.5	Remote control of the Inverter	16
5.6	User menu	17

6	HISTORICAL DATA	18
7	LOW BATTERY ALARM MENU	21
8	INSTALL LEVEL	23
9	PROGRAM MENU	25
10	ADVANCED SETTINGS	26
10.1	Testing alarm function	26
10.2	Exponent adjustment.....	26
10.3	Reset menu	27
11	ADDITIONAL INFORMATION	28
11.1	The Peukert Exponent.....	28
11.2	Time Remaining, CEF, & History.	29
12	GENERAL BATTERY INFORMATION.....	30
13	TROUBLE SHOOTING AND ERROR CODES.....	31
13.1	Trouble shooting.....	31
13.2	Error codes.....	32
14	TECHNICAL DATA.....	33
15	DIMENSIONS.....	34
16	CE DECLARATION OF CONFIRMITY	35

1 GENERAL INFORMATION

Congratulations! You are one step ahead to install the most advanced battery monitor - the Masterlink MICC from Mastervolt. This instrument will tell you at a glance:

- Exact state-of-charge of your battery;
- System voltage and system charge- or discharge current;
- Amp-hours consumed from the battery;
- Time of operation remaining until your battery is empty.
- Remote operation of your inverter, your battery charger or Mass Combi.

1.1 Use of this manual

This manual serves as a guideline for the safe and effective operation, installation, maintenance and possible correction of minor malfunctions of the Masterlink MICC.

It is therefore obligatory that every person who works with the Masterlink MICC must be completely familiar with the contents of this manual, and that he / she carefully follows the instructions contained herein. The manual must be immediately accessible to the user. This manual has 16 chapters.

1.2 Guarantee Specifications

Mastervolt guarantees that this unit has been built in accordance with the legally applicable standards and specifications. Should work take

place, which is not in accordance with the guidelines, instructions and specifications contained in the user manual, damage may occur and / or the unit may not fulfil its specifications. All of these matters may mean that the guarantee may become invalid.

1.3 Quality

During the production and prior to their delivery, all our units are exhaustively tested and inspected. The guarantee period is two years.

1.4 Validity of this manual

All of the specifications, provisions and instructions contained in this manual apply solely to the MASTERVOLT-delivered standard versions of the Masterlink MICC.

1.5 Liability

MASTERVOLT can accept no liability for:

- Consequential damage due to use of the Masterlink MICC.
- Possible errors in the manuals and the results thereof.



CAREFUL!

Never remove the type and number plate.

Important technical information required for service, maintenance & secondary delivery of parts can be found from the type and number plate.

2 SAFETY GUIDELINES & MEASURES

2.1 Warnings and symbols

Safety instructions and warnings are marked in this manual by the following symbols and pictograms:



a procedure, circumstance, etc which deserves extra attention.



CAREFUL

Special data, restrictions and rules with regard to the prevention of damage.



WARNING

a WARNING refers to possible injury to the user or significant material damage to the MICC if the user does not (carefully) follow the procedures.

2.2 Use for intended purpose

- 1 The Masterlink MICC is constructed as per the applicable low voltage directive.
- 2 Use the Masterlink MICC only:
 - in a technically correct condition;
 - in a closed room, protected against rain, moisture, dust and non condensing circumstances;
 - observing the instructions in the manual



WARNING Never use the Masterlink MICC at locations where there is danger of gas or dust explosion!

- 3 Use other than as mentioned under 2 is not considered to be consistent with the intended purpose. MASTERVOLT is not liable for any damage resulting from the above.

2.3 Organisational measures

The user must always:

- Have access to the user manual
- Be familiar with the contents of this manual. This applies particularly to Chapter 2, Safety Guidelines & Measures.

2.4 Warning for special dangers

- 1 Check the wiring at least once a year. Defects such as loose connections, burnt wiring etc. must be corrected immediately.
- 2 Do not work on the Masterlink MICC or the system if it is still connected to a power source. Only allow changes in your electrical system to be carried out by qualified electricians.
- 3 Installation must be done in accordance with local standards.
- 4 The battery voltage can be dangerous. Use caution and pay careful attention when installing the Masterlink MICC. Avoid short circuiting. Voltages above 34 V can be dangerous.

3 INSTALLATION

3.1 Tools and equipment required

Installation of the Masterlink MICC involves only eight wires and two 6 pole modular communication cables (RJ12, cross wired). The following sections describe a basic installation such as you would find on an average boat, RV or in a solar application.

First gather all the tools you need for the installation of the Masterlink MICC.

We recommend as a minimum tool kit:

- A saw to make the panel cut-out
- A 10-mm drill to make holes for feeding through the wiring between the panel, the shunt and the batteries.
- A 14 mm spanner for shunt connections
- Wire stripper and crimper
- 2 mm and 5 mm flat blade screwdrivers.

A complete set of spanners, pliers and wrenches may be helpful during the installation of the Masterlink MICC.

3.2 Materials needed for installation

Make sure you have all the parts you need for the job:

- A 500A/50mV shunt (supplied with the Masterlink MICC)
- Cable(s) long enough to easily reach from the batteries to the Masterlink MICC (maximum length of the cables: 25 meters / 80ft.):
 - *Either:* One cable 4x2x0,25 mm² shielded twin twisted pair
 - *Or:* One cable 2x0.25 mm² shielded twisted pair and three normal 2-core cables 2x0,25 mm²
- Two 6 pole modular communication cables (RJ12, cross wired; see figure 1) to connect the Masterlink MICC to the Mass Sinus inverter and the Mass charger.
- Three inline fuse holders with 2 Amp fuses (**do not install the fuses before the installation is completed**).

- An as short as possible heavy-duty battery cable to run from one shunt bolt to the main battery. The size of this cable is usually 35-70 mm² but can vary depending on the system. (Consult your Mastervolt dealer if

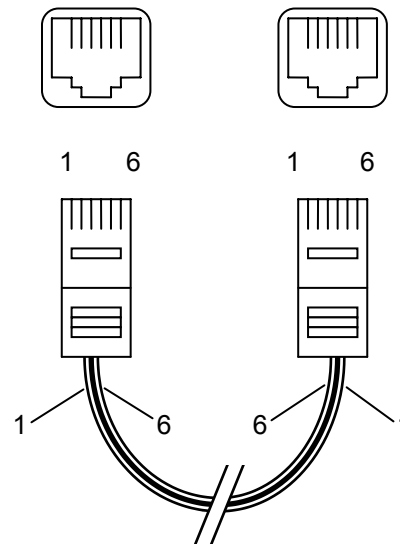

Figure 1: Modular cable, cross wired

the wire size is unknown.) This cable is commonly available from your Mastervolt dealer or at marine and auto shops.

- Cable terminals and cord end terminals.
- If an external low battery alarm is required: a normal cable 2x0.25 mm². The maximum

Mastervolt part number	Description
68 01 601100	Cable 3x2x0.25 mm ² twisted stranded wires (per meter)
68 01 601200	Cable 4x2x0.25 mm ² twisted stranded wires (per meter)
65 02 001030	Modular RJ 12/ cross wired communication cable (6 m. / 19 ft.)
65 02 100100	Modular RJ 12/ cross wired communication cable (10 m. / 33 ft.)
65 02 100150	Modular RJ 12/ cross wired communication cable (15 m. / 48 ft.)

Table 1: Ordering information for cables.

current consumption of the relay must not exceed 1A@30VDC.

3.3 Step by Step installation

 During installation check also the installation drawing on page 11.

Ideally you should install the Masterlink MICC where it is possible to gain easy access to the instrument. For good visibility avoid installing the meter in direct sunlight. The maximum (cable) distance between the meter and the shunt must not exceed 25 meters / 80ft.



WARNING

Be sure that all the charging systems in the installation are switched off or removed and disconnect the plus and minus connections from the main and secondary (starter) batteries prior to installation.

1. Make a cut out in the panel using the outline drawings of chapter 15, or integrate the Masterlink MICC in your Mastervision panel. The minimum depth required for installing the Masterlink MICC is 65 mm.
2. Make a hole in the black installation box on the side where it is easy to enter the cable.
3. Install the shunt of the Masterlink MICC as close as possible to the main battery, but avoid the shunt being in contact with the positive terminal of the batteries.

 Special care must be taken that during installation of the wiring, sharp bends of the cables are avoided. Also be careful not to run the cable on sharp edges that could easily damage the cables and the Masterlink MICC.

4. Run the twisted wired cable (2x 0,25 mm²) between the shunt and the Masterlink MICC. Be sure that the wires are long enough to be connected at the left side of the shunt. The shunt's output voltage is very low (between 0

and 50mV) Therefore reliable connections are essential. Prevent connections and wiring from corrosion. Pay attention to the correct connections (3 and 4) of the system side and the battery side (see figure 3). The maximum length of this cable must not exceed 25 meters / 80 ft.

5. Run a normal cable (2x0,25 mm²) from pin 1 and 2 (power supply) of the Masterlink MICC to the plus pole of the main battery respectively system side of the shunt. Install a fuse holder in the plus line. The maximum length of this cable must not exceed 25 meters / 80 ft.
6. Run a normal cable (2x0,25 mm²) from pin 5 and 6 (service battery voltage sense) of the Masterlink MICC to the plus pole of the main battery respectively system side of the shunt. Install a fuse holder in the plus line. The maximum length of this cable must not exceed 25 meters / 80 ft.
7. Run a normal cable (2x0,25 mm²) from pin 7 and 8 (start battery voltage sense) of the Masterlink MICC to the plus respectively the minus pole of the secondary battery. Install a fuse holder in the plus line. The maximum length of this cable must not exceed 25 meters / 80 ft.

 **Please note that the 2 Amp fuses should only be installed after the installation is completed.**

 Note: for the above mentioned cables wires also a 8 wire cable (8x 0,25 mm²) with twisted pair wires can be used (see also chapter 3.2).

8. Run a 6 pole modular communication cable (RJ12, cross wired) and connect the RJ12 connector to the socket on the right-hand side (see figure 2: connector I) at the backside of the Masterlink MICC.

To connect the other RJ12 connector to the apparatus:

- Refer to the **charger's** installation manual to connect the RJ12 connector.
- **Mass Combi:** You must connect the RJ12 connector to the "QRS-232" input (Data bus connections) see figure 4.

9. Run another 6 pole modular communication cable (RJ12, cross wired) and connect the RJ12 connector to the socket which is marked with "Inv" (see figure 2: connector II) at the back of the Masterlink MICC.

To connect the other RJ12 connector to the apparatus:

- Refer to the **inverter's** installation manual to connect the RJ12 connector.
- **Option for the Mass Combi:** Connect the RJ12 connector to the "REMOTE" input (Data bus connections) see fig. 4.

 **NOTE:** under normal circumstances there is no need to install this optional cable. If this cable is installed, the total stand-by power consumption will be reduced from 50mA to 30mA if the Mass Combi is switched off by means of the Inverter button on the Masterlink MICC panel.

When installed, it is not possible to connect the ICC remote control panel to the Mass Combi.

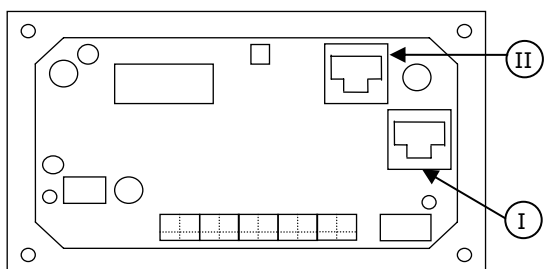

Figure 2: Backside MICC panel

10. Connect the wires to the connection terminals of the Masterlink MICC and mount the panel with the four factory supplied nuts and rings.

11. Connect the minus wire of the system to the system side (see figure 3) of the shunt.

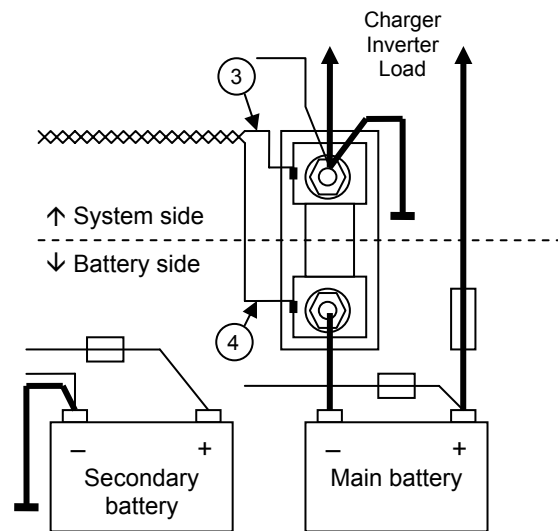



Figure 3

12. Make a connection between the minus of the secondary (starter) battery and the system side (figure 3) of the shunt.

13. Connect the battery side of the shunt (figure 3) to the minus terminal of the main battery.

 **NOTE:** if several minus cables are connected to the minus terminal of the main battery, all of these cables must be connected to the system side of the shunt. On the battery side only one cable between shunt and main battery is used.

14. Reconnect the positive terminals of the batteries to the system.

15. **Double check** the wire connection of the meter and install the three 2 amp fuses.

Directly after power up by installing the two 2 amp fuses the LED's will light and after approximately five seconds the display will show the volt, amps, state of charge and the time remaining of the main battery.

If this is not the case, check the wire connections for errors. Consult to the trouble shooting chapter if the wires are connected correctly but the meter is not showing the display (chapter 13).

3.4 Installation of an external alarm

The switching current of the alarm relay (normally open contact) may never exceed 1A@30VDC. The switching contacts of the relay are available on pin 9 and 10.

3.5 Connection of the charger and the inverter

Always connect the cables between batteries and charger and inverter, before you connect the Masterlink MICC to the charger or inverter. If it is necessary to disconnect batteries and charger/inverter, then first disconnect Masterlink MICC from the charger/inverter

For an appropriate operation of the Masterlink MICC the "ON/OFF" switch of the inverter must be set to the "REMOTE" position.

If you are using a *Mass Combi* then the ON/OFF/CH. switch on the front of the *Mass Combi* must be set in the "ON" or "Ch. Position". See chapter 4 of the manual of the *Mass Combi*.

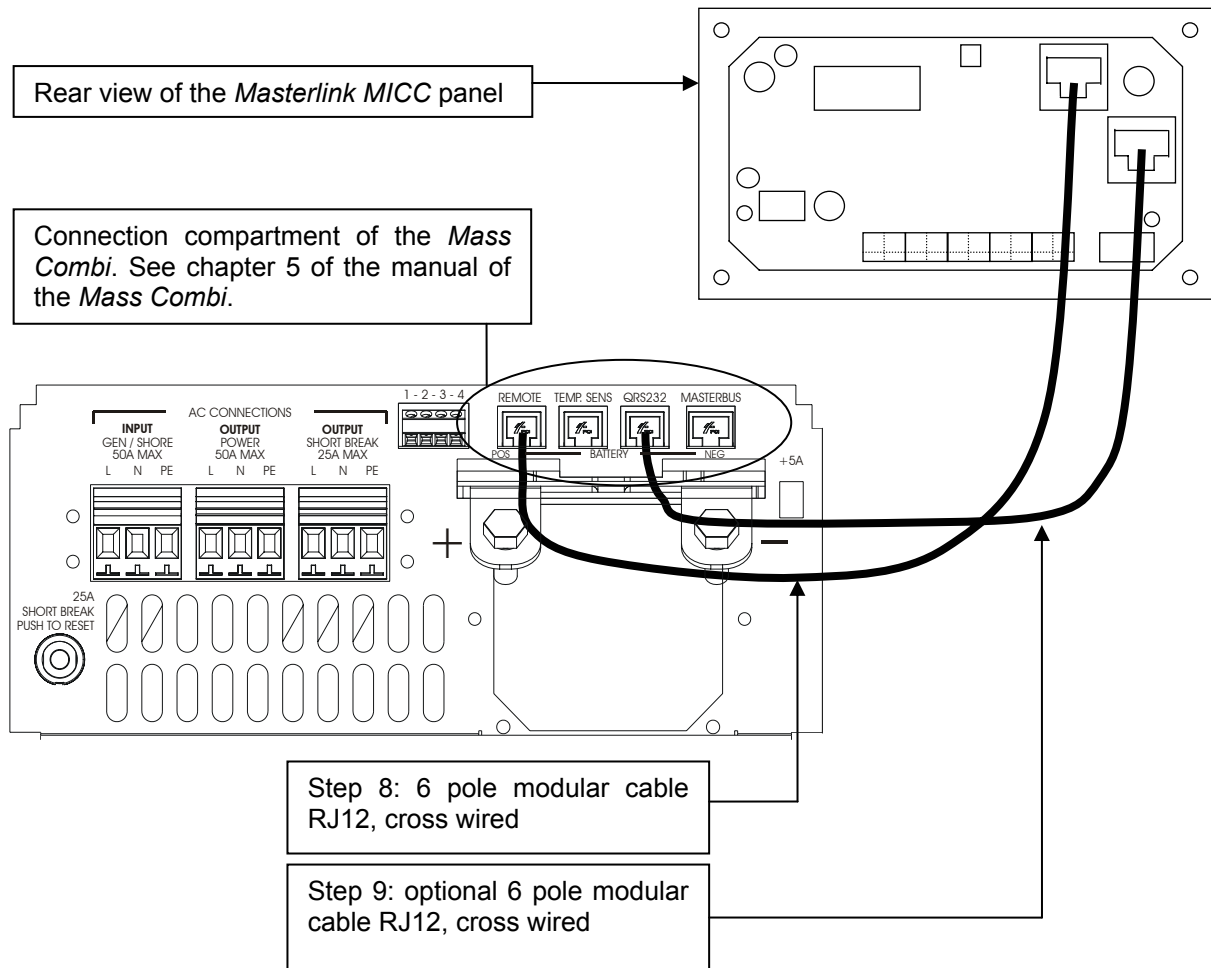
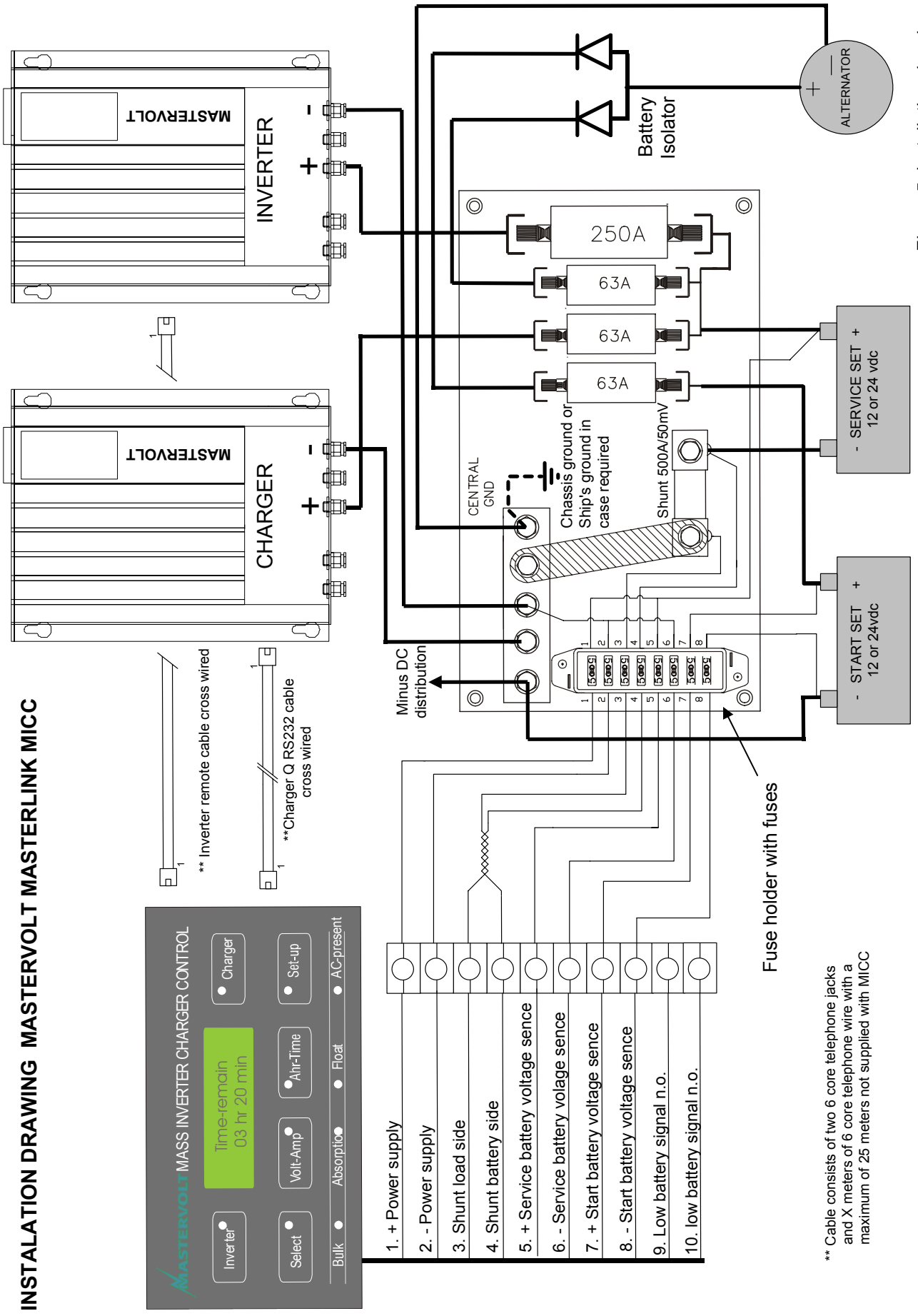

Figure 4: Connection between the Masterlink MICC panel and the Mass Combi

INSTALLATION DRAWING MASTERVOLT MASTERLINK MICC



**** Inverter remote cable cross wired**

****Charger Q RS232 cable cross wired**

**** Cable consists of two 6 core telephone jacks and X meters of 6 core telephone wire with a maximum of 25 meters not supplied with MICC**

Figure 5: installation drawing

4 SYNCHRONISATION AND SETTING THE BATTERY CAPACITY



See also chapter 8.

4.1 Synchronisation

Although the meter is for many items "self-learning" it is necessary, for a quick start-up, to set the meter according to the voltage and capacity of the installed batteries. To synchronise the meter with the installed batteries, charge the batteries after the installation of the Masterlink MICC for at least 24 hours with an appropriate charger to be sure the batteries are 100% charged. After this time the "FLOAT"-LED will be lit indicating the battery is fully charged. The Masterlink MICC can now be synchronised with the installed battery.

4.2 Setting the battery capacity

The factory default for the battery capacity is set at 200 Ah. For high accuracy of the "time remaining" function and the "percentage charged" indication, the meter must be set according to the battery capacity installed. The following steps will make sure that the right battery capacity is set and the readings are as accurate as possible.



Note: the capacity of the battery can only be set if the batteries are 100 % charged. The time remaining function and the Ah consumed will be reset if the battery capacity settings are changed.



Select

Press the **Select** button for 5 seconds until the green Select indication LED flashes.



Ah-Time

Press the **Ah-Time** button shortly to display the battery capacity.



BATTERY CAP.

200 Ah



Set-up

Adjust the required capacity of the main battery by pressing the **Set-up button**



Select

If the **Select button** is held for five seconds, the arrow's direction in the right part of the display will change. If the arrow is pointing downwards (↓) the set value can be changed into lower values by means of the **Set-up button**. If the arrow is pointing upwards (↑) the set value can be changed into higher values.



If the battery capacity is set and no buttons are used the Masterlink MICC will reset to the users menu after 15 seconds.

For 12-volt systems the capacities of all the installed batteries for the main battery bank can be added. If a 24-volt battery system is used all the capacities of the main battery bank are added and divided by two.

Example:

A main battery bank with two batteries installed of 12-volt 100 Ah each.

For a 12-volt system the battery capacity must be set at 200 Ah. For a 24-volt system the battery capacity must be set at 100 Ah.

The auxiliary (starter) battery capacity doesn't need not to be set.

4.3 Setting the battery voltage

Normally it will not be necessary to set the battery voltage; the meter automatically detects a 12 or 24-volt main battery system. Special care must be taken that the battery must be charged at least 50 % before power up. If this is not possible or the state of charge of the battery is unknown the battery voltage needs to be adjusted.

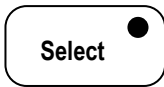

Press and hold the **Select button** for 5 seconds until the green Select indication LED flashes.

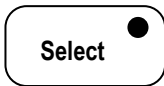

Press the **Select button** five times shortly until "BATTERY BANK" is displayed.

BATTERY BANK
24V



Set the required voltage of the main batteries using the **Set-up** button.

The Masterlink MICC will now be synchronised and set in accordance with the installed batteries.

4.4 Activate Mass Combi setting

You only have to activate (ON) this setting if you are using the Masterlink MICC in combination with the Mass Combi. The default setting is "OFF".

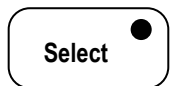

This menu can be entered by holding the **Select** button for 5 seconds until the Select-LED is flashing.

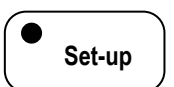

Now press the **Set-up**-button shortly to enter the "program menu"

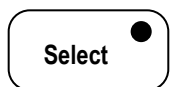

Press the **Select** button 4 times shortly until the "HFC MODE" is displayed.

HFC MODE
OFF

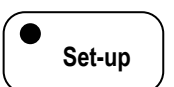

Select the required setting using the **Set-up** button.

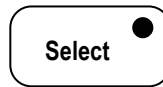

EXIT LEVEL
->PRESS SET-UP

If this level is entered you can return to the user menu by means of the **Set-up** button.

4.5 In case you are lost

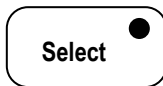

If it is necessary to reset to factory defaults, go to the "PROGRAM LEVEL" by holding the **Select button** and **Set-up button** simultaneously until both the Select-LED and the Set-up-LED are flashing.

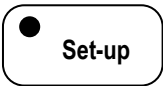

Next press the **Set-up** button shortly until "RESET FACTORY" is displayed.

RESET HISTORY
PRESS SET 5sec



After holding the **Set-up**- button for 5 seconds the unit will be reset to factory defaults.

5 OPERATION

5.1 General

By means of the Masterlink MICC you can switch on and off your inverter and charger remote controlled and read the exact state-of-charge of your battery.

The (dis)charge current is measured by means of a shunt, and on demand made visible on the display. From the starting point of fully charged batteries, the Masterlink MICC calculates the actual battery capacities. For this calculation the measured (dis)charge currents are used as well as assumptions about their effect on battery capacity. The accuracy of the results of this calculation depends on the correctness of these assumptions. These assumptions are partly set up by the user (possibly after a test) and partly set up by the Masterlink MICC itself after a number of charge/discharge cycles.

The operation of the Masterlink MICC can be separated into three major parts: remote control of the battery charger, remote control of the inverter and retrieving information you're your batteries. (see figure 6)

5.2 Remote control of the battery charger

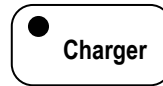

By pressing the “Charger”-switch the battery charger can be switched on/off. After a few seconds the “Charger”-LED illuminates when the charger is in operation (230V supply). The “AC-present”-LED illuminates as well.



WARNING

Above operation is not applicable for the chargers IVO Smart 12/25, 12/35, 12/40, 12/50 and 24/15, IVO Compact 12/25 and 24/10 and MASS 12/30, 24/15 and 24/25. When the charger is switched off by means of the Masterlink MICC (the Charger-LED is not illuminated), the maximum output current is reduced to 10%. To switch off the battery charger completely, the “ON-OFF”-switch of the battery charger must be set to the “OFF”-position.

The meaning of the illuminating LEDs is explained beneath. Refer to the charger’s users manual for additional information about the

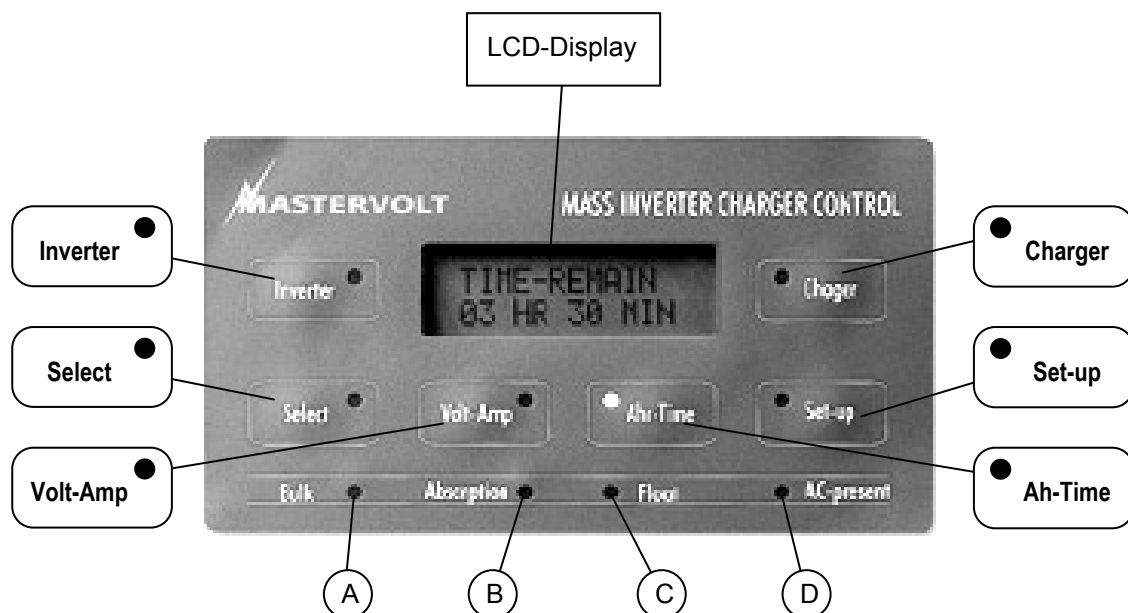

Figure 6: Operation of the Masterlink MICC

three-stage charge characteristic.

The LEDs A, B, C and D represent the following information (see figure 6 for the references indicated between brackets []):

Bulk [A]: Main charge

Batteries are charged with full charger output current at a voltage between 12V resp. 24V and 14.4V resp. 28.8V.

Absorption [B]: absorption charge

The batteries are almost (approx. 85%) charged. Charging continues with decreasing current until the batteries are full.

Float [C]: “trickle charge”

The batteries accept only a small current. Voltage is lowered to 13.2V resp. 26.4V to keep the battery fully charged without formation of gases.

AC present [D]:

The AC-present –LED illuminates if the charger is in operation (230V supply). Besides the inverter there is an external 230V AC source available.

5.3 Adjustment of the maximum charge current

When the available current from the AC source is limited (for instance to avoid the shore fuse from tripping), the output current of the charger can be reduced (and accordingly the AC-power consumption of the battery charger):

 Press the **Select** button for 5 seconds until the green Select indication LED flashes.

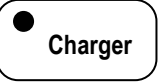
 Press the **Charger**-button shortly to display “CURRENT CONT.”

CURRENT CONT.
100% ↑

 Adjust the desired output current (10 – 100%) by pressing the **Set-up button**

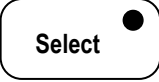
 If the **Select button** is held for five seconds, the arrow’s direction in the right part of the display will change. If the arrow is pointing downwards (↓) the set value can be changed into lower values by means of the **Set-up button**. If the arrow is pointing upwards (↑) the set value can be changed into higher values.

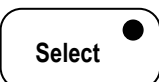
 After adjusting the output current to the desired value, press the “**Select**”-button shortly until “EXIT LEVEL” is displayed.

EXIT LEVEL
->PRESS SET-UP

 Now it is possible to return to the user menu by means of the Set-up-button. Also if none of the buttons was used for 15 seconds the Masterlink MICC returns to the users menu.

5.4 Adjustment of the Power sharing / Power support level (Mass Combi only).

When the available current from the AC source is limited (for instance to avoid the shore fuse from tripping), the maximum current can be limited. In case of the Mass Combi you can adjust the *Power sharing / Power support** level.

 Press the **Select** button for 5 seconds until the green Select indication LED flashes.

*See chapter 7.7 of the manual of the Mass Combi to enable *Power sharing / Power support* function.

MICC User level					
Direct access by pressing desired function button shortly					
Select =>	Inverter	Volt-amp	Ahr-time	Charger	Set-up
DEPT 1	I01 Inverter switch status ON - OFF	V01 Voltage & Current read out Service Battery	T01 Battery Status present in % full	C01 Charger switch status ON-OFF	H01 Battery historical data
DEPT 2		V02 Voltage read out Starter battery	T02 Time remainig present in hours		H02 Deepest Discharge
DEPT 3			T03 Battery Capacity Consumed read out in Ahr		H03 Peukert Exponet
DEPT 4					H04 C.E.F.
DEPT 5					H05 Numbers of cycles detected
DEPT 6					H6 Software version
DEPT 7					H07 Error status

Figure 7: Set-up drawing (user level).

Charger Press the **Charger**-button shortly to display "CURRENT CONT."

CURRENT CONT.
25A ↑

Set-up You can adjust the *Power sharing / Power support* level between 2.5A and 25A in steps of a 0.5A by pressing the **Set-up** button.

Select If the **Select** button is held for five seconds, the arrow's direction in the right part of the display will change. If the arrow is pointing downwards (↓) the set value can be changed into lower values by means of the **Set-up** button. If the arrow is pointing upwards (↑) the set value can be changed into higher values.

Select After adjusting the output current to the desired value, press the **Select**-button shortly until "EXIT LEVEL" is displayed.

EXIT LEVEL
->PRESS SET-UP

Set-up Now it is possible to return to the user menu by means of the **Set-up**-button. Also if none of the buttons was used for 15 seconds the Masterlink MICC returns to the users menu.

5.5 Remote control of the Inverter

Inverter By pressing the **Inverter**-switch the inverter can be switched on and off. After a few seconds the **Inverter**-LED illuminates when the inverter is in operation (AC-output).

5.6 User menu.

Functions like battery voltage, current consumption and time-remaining are displayed by means of the LCD display

This information can also be used to control an optional Battery Alarm relay. Refer to chapter 7, 8, 9 and 10 for adjusting and programming functions of the Power System Control Panel.

 For more information see also the set-up drawing (figure 7). The numbers of the mentioned levels correspond with this drawing.

Battery voltage and current (V01)

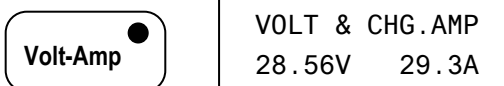

By pressing the **Volt-Amp**-button the LCD-Display shows the main battery voltage and current. If the battery is being charged, "VOLT & CHG.AMP" is displayed. "VOLT & DIS.AMP" means that the battery is being discharged with the current that is displayed.

Voltage secondary (starter) battery (V02)

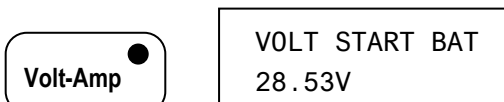

By pressing the **Volt-Amp**-button again, the voltage of the secondary (starter) battery is displayed. Please note that if no secondary battery was installed, this function is not available. The Masterlink MICC automatically detects whether a secondary (starter) battery is connected to the meter.

Battery status (T01)

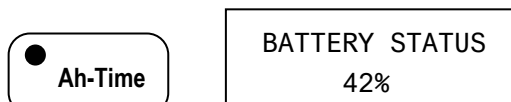

By pressing the **Ah-Time**-button the LCD-Display shows the state of charge of the main battery as a percentage of the installed battery capacity. This percentage gives an exact indication of the state of charge of the battery. This value is automatically compensated by the

charge efficiency factor (C.E.F.) and the Peukert exponent (check chapter 11 for more information about the C.E.F. and about the Peukert exponent).

A battery is considered fully (100 %) charged if:

1. All of the Ah's discharged are charged back into the battery plus 1 Ah (real counting without CEF).
2. The charge-float voltage is met (the voltage is usually set around 14.0/28.0 volt).
3. The charge-return current is met (the charged current will be usually be set for 2 % of the installed battery capacity).

If all the above parameters are met for a few minutes, the reading of the Ah's consumed will be reset to 100%.

Time remaining function (T02)

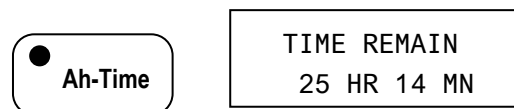

If you press the **Ah-Time**-button again, the display shows how long the battery can be used before it will be empty and needs to be recharged. The remaining time is automatically compensated with the Peukert exponent if the battery is discharged above the 20h rating (see chapter 11 for more information about the Peukert exponent)

Ah consumed (T03)

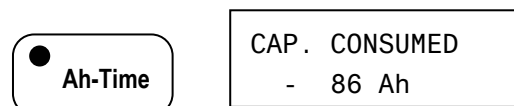

If **Ah-Time**-button is pressed again, information is shown on how many amp hours are consumed from the battery. During charging this value shows how many Ah's are still necessary to bring the battery up to a 100 % state of charge (0 Ah consumed). This value is compensated by the Charge Efficiency Factor (C.E.F.).

6 HISTORICAL DATA

To know the history of your battery can be very useful. It will help you to check if the battery is has the right capacity for the application, and how long the battery can be used before it need to be replaced. This can be done by reading the number of cycles the battery has used, and the efficiency (C.E.F.) of the battery. The memory back up system of the MICC makes this data available even if the power supply of the meter removed or, if the battery completely discharged to 0 volts.

 For more information see also the set-up drawing (figure 7). The numbers of the mentioned levels correspond with this drawing.

Battery history data (H01)

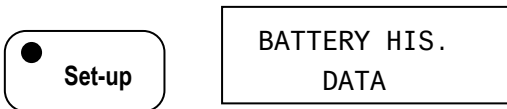

To enter the historic data menu press the **Set-up** button once. With the **Select** button you can scroll trough a total of 6 information levels.

Deepest discharge (H02)

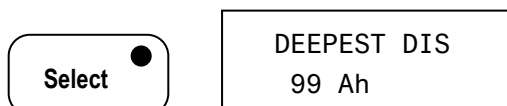

By touching the **Select**-button once, the deepest discharge of the battery is displayed. This value lets you know the deepest discharge of the battery since power up of the MICC or after a historic data reset. For an optimum lifetime of your battery it is advised not to discharge a battery below 80 % of its rated capacity. If a battery is frequently discharged below this value, premature failure of the battery can be expected.

Peukert exponent (H03)

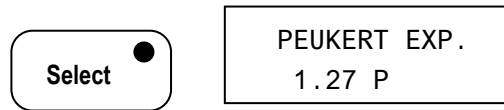

The second level shows the Peukert exponent. Standard batteries are rated for a 20-hour discharge. This means that a 100 Ah battery can supply 5 amps for 20 hours before a voltage of 1,75 volt/cell (10,5 volt for 12-volt batteries and 21 volt for 24-volt batteries) is reached.

If the discharge current is higher, for example 10 amps the battery will not be able to supply the full 100 Ah. In this case the voltage of 1,75 volt/cell or 10,5/21 volt is reached before the battery has supplied its full 20-h rated capacity. Frequently discharging the battery below this voltage and/or capacity will shorten the life of the battery dramatically.

The maximum time the battery can be used in the above mentioned example is approx. 8 hour i.e. 80 Ah.

A German scientist Dr Peukert, has found an exponent that can be used to calculate the capacity of the battery, if it is used above its 20 h rating. This exponent is used by the MICC to calculate the time the battery can be used (time remaining function). The Peukert exponent is also used to calculate the state of charge in percentage.

In normal circumstances the Peukert exponent is no needs to change, only if traction batteries e.g. on a forklift, are used, and a high level of accuracy is required. The Peukert exponent can be changed in the program mode. See section for how to calculate the Peukert exponent and section how to set the MICC according to the exponent found.

Charge Efficiency Factor C.E.F (H04)

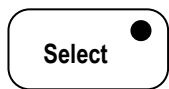

C . E . F . 90 %

The third level is the C.E.F (Charge Efficiency Factor). Every combination of battery and charger has an total efficiency. This means that there must be more Ah charged into the battery than are used. A standard wet type lead acid battery has an efficiency of approx. 80 %, a gel type battery has an efficiency of approx. 90 %. The efficiency of a battery is improved after it has been used for 5-10 cycles. For the rest of the lifetime of the battery the efficiency will slowly decline depending on its age and the number of discharge cycles. If an efficiency of 70 % is reached, it will basically mean that the battery is at the end of its lifetime and needs to be replaced. The changing of the efficiency means that it is necessary to calculate the efficiency every charge and discharge cycle. The C.E.F. is not only for the reading of the charge and discharge information of the MICC, but also for the calculation of the time remaining function.

Number of cycles (H05)

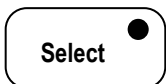

NUMBER CYCLES 10

The fourth level gives information about the number of 35 % (low battery set point) cycles used from the battery after the Masterlink MICC was set up or after the Masterlink MICC was reset to factory settings.

The number of cycles a battery can handle depends strongly on the type of battery and its quality. One cycle is reached if the battery is discharged from 100 % state of charge down to 0 % followed by a charge up to 100 %. One cycle is also reached if a battery is discharged twice to 50 % and charged back to 100 % or discharged four times 25 % and charged to 100 % etc.

A normal cranking battery can perform approx. 50-80 cycles before the end of its cycle life is reached. A semi traction battery can perform about 200-250 cycles and full traction batteries can handle 1000-1500 cycles before the end of their cycle lifetime is reached. The number of cycles the battery is used together with the C.E.F. of the battery gives a reasonable indication about how long the battery can be used before it needs to be replaced.

Every time the battery is discharged below 35 % of its rated capacity and charged back to at least 85 % of its capacity, one cycle is counted.

Software version (H06)

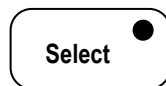

SOFTWARE VER. 1.02

The fifth level of this menu displays the software version installed in your MICC. This software version can be used for future references.

Error status (H07)

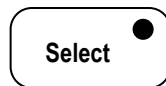

ERROR STATUS NONE

The sixth level shows the error status (see the low battery alarm settings for more information).

At this level it is possible to return to the user menu by means of the **Set-up button**. Also if none of the buttons are used for 15 sec the MICC returns to the users menu.

MICC Installer level					
Hold select 2..4 sec untill led flashes and select the function below					
Select =>	Inverter	Volt-Amp	Ahr-time	Charger	Set-up
DEPT 1	No function level 1	M01 Set Low Voltage Level Low Battery Signal 11vdc / 22vdc	A01 Battery Capacity 200 ah 40 .. 9990 ah	C01 Current Control 100% amp 10%..100%	F01 Sleep mode On / Off
DEPT 2		M02 Set discharge Floor 35% of C.ahr 20% .. 50%	A02 Average Time Consumption 0 minutes 0-10-20-30 minutes	C02 Exit level	F02 Low Bat. Contact On / Off
DEPT 3		M03 Set level full charge 80% of C.ahr 70%..90%	A03 Return amps 6% of C.ahr 1%..10%		F03 LED is switch On / Off
DEPT 4		M04 Set min. require run time 10 min 5 min .. 90 min	A04 Float level 13.1V / 26.2V		F04 HFC mode On / Off
DEPT 5		M05 Exit level	A05 Reset Ahr to 0000 Press setup		F05 Exit level
DEPT 6			A06 Battery type 12 /24V		
DEPT 7			A07 Exit level		

Figure 8: Set-up drawing installer level

Program level - advanced settings					
Hold select & setup 2 to 4 sec untill both leds flashes					
SELECT & SETUP	Inverter	Volt-amp	Ahr-time	Charger	Set-up
DEPT 1	No function level 2	M06 Test Low Batt. mode on - off	A08 Change Peukert exponent 1,27 1,01 to 1,50	No function level 2	F06 Reset to factory setting Press setup
DEPT 2		M07 Exit level	A09 Change C.E.F. Manual actual read out 0.7... 0.99		F07 Reset all historical data Press setup
DEPT 3			A10 Exit level		F08 Exit level
DEPT 4					
DEPT 5					
DEPT 6					

Figure 9: Set-up drawing advanced settings

7 LOW BATTERY ALARM MENU

The Masterlink MICC checks the state of charge of the battery continuously and gives an alarm when the battery is reaching a low voltage set point or a low discharge floor. The Masterlink MICC is provided with a relay to control an external alarm (check also chapter 3.4 for more information).

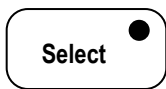

To enter the Alarm menu hold the **Select** button for 5 seconds until the Select-LED flashes.



Now press the **Volt-Amp** button to enter the low batter alarm menu.

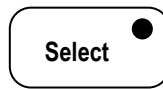

With the **Select** button you can now scroll through the levels of this menu and adjust several alarm set points.



For more information see also the set-up drawing (figure 8) and figure 10. The numbers that are mentioned behind the levels correspond with this drawing.



Note: If the **Select** button is held for five seconds, the arrow in the right part of the display will change. If the arrow is pointing downwards (↓) the set value can be decreased by means of the **Set-up** button. If the arrow is pointing upwards (↑) the set value can be increased.

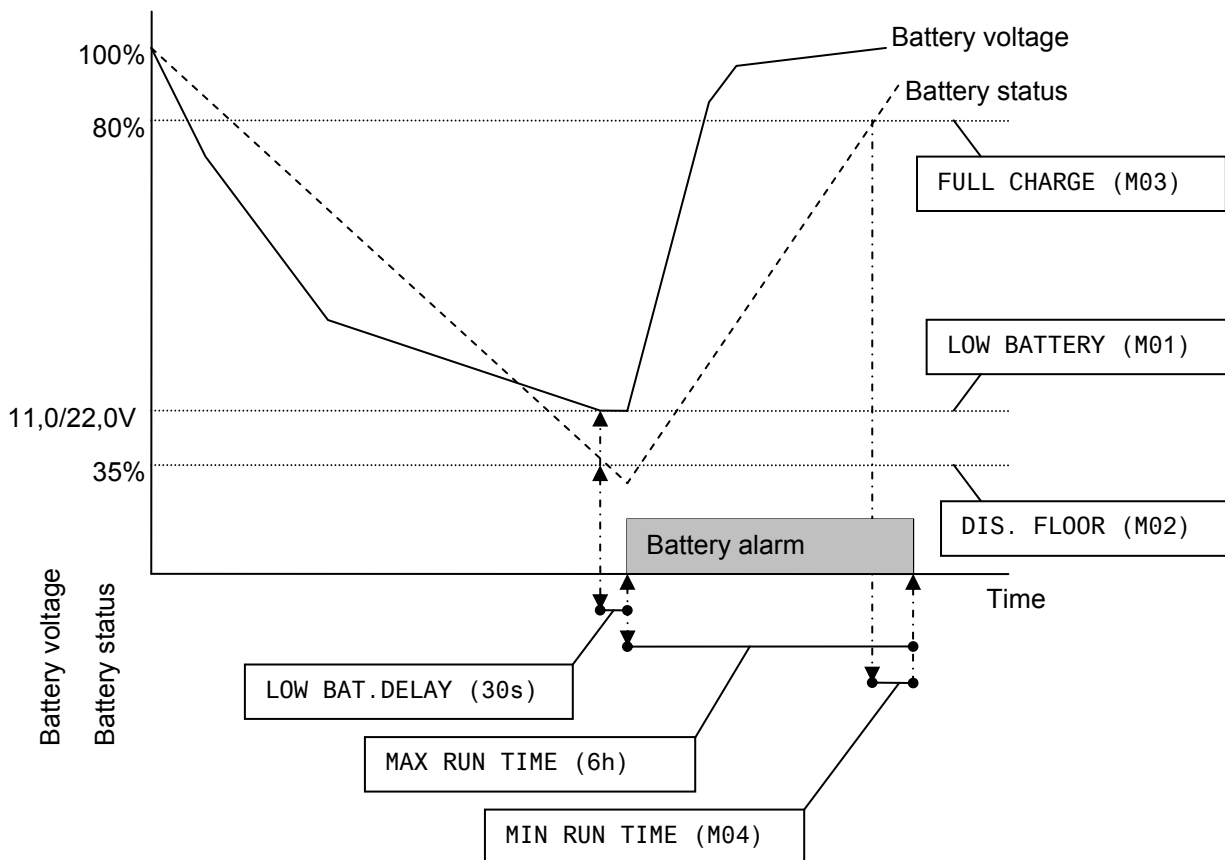
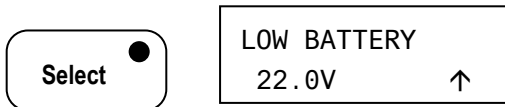

Figure 10: battery alarm settings

Low battery alarm voltage set point (M01)



The MICC automatically detects a 12 or a 24-volt system. The factory default for the low battery alarm is 11 volt if a 12-volt system is used or 22 volt if a 24-volt system is used. These values are correct if the battery is discharged by the C 20 rate. If the discharged rate is higher i.e. if the current is high, the low voltage alarm may set slightly lower; for example 10 / 20 volts. When the average current is much lower than the C 20 rate this set point can be set higher for example 12 / 24-volt. For solar applications this voltage alarm can set higher to avoid too deeply discharged batteries.

Low Ah set point (M02)

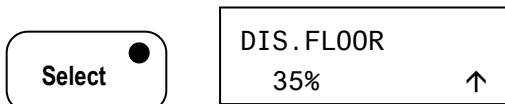

At the second level of this alarm menu the alarm can be set according to the Ah consumed. Battery voltage is not always correct to set an alarm. The voltage of a battery is not only affected by the state of charge of the battery, but is also affected by the load connected to the battery during discharge. The alarm for the low Ah discharge floor is factory set at 35 % of the total capacity of the battery. For an average battery installation this value is normally ok, but the alarm for low Ah can be set according to the requirements of the application. For solar applications this value is often set to 50 % and for cyclic applications (forklifts) the value is often set at 20 %.

Alarm delay

The alarm is delayed for 30 sec. This means that if the voltage is lower than the setting for low battery voltage, the alarm will be activated after 30 seconds. This prevents the alarm being activated during a small dip in the battery voltage.

Low battery alarm "off" setting (M03)

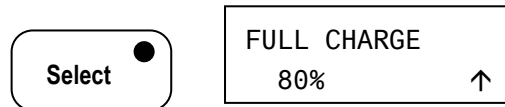

The fourth level is used to reset the alarm if the battery reaches 80% state of charge. This means with the factory default settings of 35 % for low alarm, and 80 % for switching of the alarm, the alarm is activated if the Ah consumed drops below 35 % and it is reset when the batteries have been charged up to 80 % of their capacity. The value can be set between 70 and 90 % according to the requirements of the system.

Minimum alarm time setting (M04)

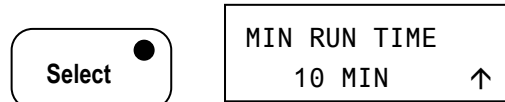

The fifth level of this alarm setting is used to set the minimum time that the alarm will stay activated. If for example the battery drops below the settings for voltage and Ah but is charged directly afterwards, the alarm will stay activated for 10 minutes (factory setting) even if the battery is charged above the settings for voltage and Ah. This time can be adjusted between 5 and 90 minutes by means of the **Set-up button**.

Maximum alarm time

The maximum alarm time is set for 6 hours and used to set the maximum time the alarm will stay activated. If for example the battery is discharged below the settings for voltage and Ah and will not be charged the alarm will stay activated for a maximum of 6 hours.

Return to users menu (M05)

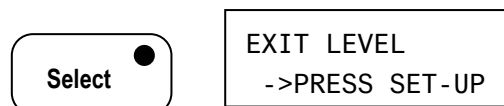

If this level is entered, it is possible to return to the user menu by means of the **Set-up button**. Also if none of the buttons are touched for 15 seconds, the Masterlink MICC will return to the users menu.

8 INSTALL LEVEL

This menu is used to set the Masterlink MICC according to the voltage and capacity of the batteries installed.

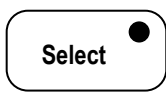
 To enter the install level press the **Select** button for 5 seconds until the Select LED is flashing.

 Next press the **Ah-Time** button to enter the installer menu.

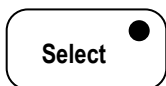
 With the **Select** button you can scroll through the levels of this menu.

 For more information see also the set-up drawing (figure 8). The numbers of the mentioned levels below correspond with this drawing.

 Note: If the **Select** button is held for five seconds, the arrow in the right part of the display will change. If the arrow is pointing downwards (↓) the set value can be decreased by means of the **Set-up** button. If the arrow is pointing upwards (↑) the set value can be increased.

Setting the battery capacity (A01)

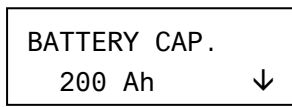
The first level is used for setting the battery capacity. For an accurate reading of the time remaining function, and the capacity consumed in % of the installed capacity, this level must be set according to the capacity of the battery installed. The set value is the capacity of the battery with a 20 hour rating (C 20). If traction batteries are installed with a different rating such as C 10 or C 8, ask your battery supplier what the capacity of the battery will be if the battery is discharged according to the 20-hour rating and set the MICC according to this value.

For 12-volt systems the capacities of all the installed batteries of the main battery bank can be added. If a 24-volt battery system will be used all the capacities of the main battery bank are added and divided by two.

Example: a main battery bank with two batteries installed of 12-volt 100 Ah each.

For a 12-volt system the battery capacity must be set at 200 Ah. For a 24-volt system the battery capacity must be set at 100 Ah.

The auxiliary (starter) battery capacity does not need to be set.

 Please note that the capacity of the battery only can be set if the batteries are 100 % charged. The time remaining function and the Ah consumed are reset if the battery capacity settings are changed.

Average time for the time remaining function (A02).

With the second level it is possible to set the average time for the time remaining function. If this set point is set to 0 it means that the time remaining is instantaneous and will give direct information about how long the batteries can be used in accordance with the load connected. A more accurate and easier way to use value is shown if the average reading is set to 10, 20 or 30 minutes. If this level is entered, the value can be set by means of the **Set-up** button. The factory default for this level is 10 minutes.

Setting the "charged" amperage (A03)

Another point that needs to be met before the Masterlink MICC considers the battery fully

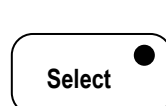
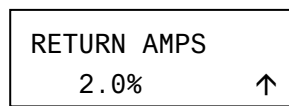
charged is the number of amps flowing into a fully charged battery. The more a battery is charged the less current it requires. If this current drops below 2 % of the installed battery capacity (C 20 rating), the battery can be considered as fully charged, provided the charged voltage is met as well. If the battery becomes a lot older (beyond its normal lifetime) it might start to consume more current when the battery is fully charged so the meter can not be reset to zero and efficiency can not be calculated correctly. This means that this set point needs to be changed to a higher value if old batteries are used which are beyond their economical life but can not yet be replaced. The "charged" amps can be changed between 1 and 10 % of the installed capacity and the factory default is 2 %.

Setting the "charged" voltage (A04).

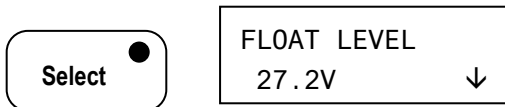

In order to check if the battery is fully charged several parameters must be met before the MICC will consider the battery fully charged. One of the parameters is the minimum voltage that must be reached. This voltage must be set according to the lowest voltage of all the charging devices in the system. This means for example if the voltage of the battery charger is 14.25 volt and the alternator is 14 volt the voltage must be set just below the lowest voltage i.e. below 14 volt.

The above mentioned voltages are measured at the output terminals of the charging system and therefore it is necessary for these voltages to be set approx. 0.4 volt lower to compensate for the voltage drop in the wiring. In the above mentioned example therefore the voltage must be set for 13.6 volt.

Also this value will be automatically set for a 12 or a 24-volt system. The factory settings are 13,6 volts for a 12-volt system or 27,2 volt for a 24-volt system.

Resetting the Ah consumed (A05)

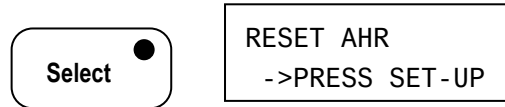

With the fifth of this menu the consumed Ah can be reset back to zero by the **Set-up** button for 5 sec. This will only be required if the MICC is out of synchronisation caused by wrong settings or if the batteries are replaced.

 Only reset the consumed Ah's if you are sure the batteries are 100 % charged.

Setting the battery voltage (A06)

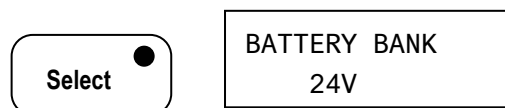

The last level is used to set the Masterlink MICC according to the battery voltage of the main battery. If the Masterlink MICC is powered up with a full or at least a reasonably charged battery, the MICC will automatically set the voltage according to the nominal voltage of the main battery system. If during power up of the Masterlink MICC a 24-volt battery was completely discharged i.e. the voltage was below the 15 volts, the meter is set for the wrong voltage. The right voltage can be set with the **Set-up** button. The factory default setting is 12 volt.

Return to users menu (A07)

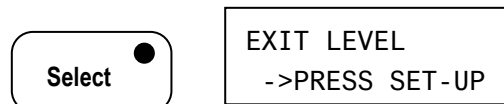



If this level is entered you can return to the user menu by means of the **Set-up** button.

9 PROGRAM MENU

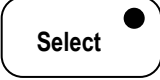
The Program menu is used to set the Masterlink MICC according to the user's requirements.

 This menu can be entered by and holding the **Select** button for 5 seconds until the Select-LED is flashing.

 Now press the **Set-up**-button shortly to enter the "program menu"

 With the **Select** button you can scroll through the levels of this menu.

 For more information see also the set-up drawing (figure 8). The numbers of the mentioned levels below correspond with this drawing.

Sleep mode (F01)

The first level that can be set is the sleep mode. For an even lower power consumption of the MICC, as often required in solar applications, the MICC can be set so that the backlight of the display will be switched off if the buttons are not used for 15 seconds. In this way the power consumption is reduced till 28 mA. As soon as one of the buttons will be touched the display will be lit again for an easy reading of the display. This function is very useful if smaller battery capacities are used or in solar applications where as low a possible power consumption as possible is required. The sleep mode can be switched on or off by means of the **Set-up** button. The factory default setting is "On".

Setting alarm function on or off (F02)

With the second level it is possible to switch the output of the alarm function on or off. The alarm status will still be shown in the display but the external alarm contact of the MICC will not be activated (check chapter section for more information about alarm settings). If this mode is entered, the alarm function can be switched on or off by means of the **Set-up** button. The factory default for this level is off.

Adjustment of the charger/inverter LED-indication (F03)

With the third and last level it is possible to change the function of the LED-indication of the charger and inverter buttons. Factory settings for this function is 'OFF' which means that the charger LED and the inverter LED will only illuminate when the battery charger, respectively the inverter are actually switched on and that they are operating without failures. With the **Set-up** button you can switch this function to 'ON'. When switched ON the indication LED will illuminate as soon as the Battery charger or the inverter is switched on by means of the Charger-button, respectively the Inverter-button. Then the LED will illuminate immediately, whether the charger is operating without failures or not.

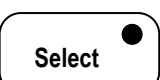
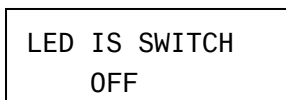
Activate Mass Combi setting (F04)

You only have to activate (ON) this setting if you are using the Masterlink MICC in combination with the Mass Combi. The default setting is "OFF".

Return to users menu (F05)

If this level is entered you can return to the user menu by means of the **Set-up** button.

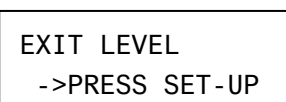
10 ADVANCED SETTINGS

After pressing and holding the **Select** and **Set-up** buttons simultaneously for 5 seconds several adjustments can be made to set the Masterlink MICC according the users requirements. However, under normal circumstances these adjustments should not be changed. Refer to figure 9 for more the set-up drawing of these advanced settings. The numbers below between brackets () correspond with this drawing



CAREFUL!

Adjustments in the Advanced settings menu can result in deviation in the functioning of the MICC when incorporated incorrectly. For more information see also the set-up drawing.

10.1 Testing alarm function

At this level the low battery function can be tested without draining the battery.



This menu can be entered by pressing and holding the **Select** and **Set-up** buttons simultaneously for 5 seconds until the Set-up LED and the Select LED flash.

Testing alarm function (M06)



Press the **Volt-Amp** button to enter the menu

With the **Set-up** button you can toggle the alarm function between ON and OFF, independently of the state of charge, to test the alarm functions.

Return to users menu (M07)

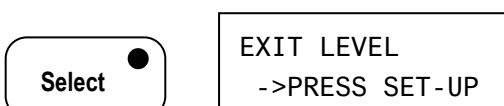

By pressing the Select button, you can scroll to the 'EXIT-LEVEL' If this level is entered you can return to the user menu by means of the **Set-up** button.

10.2 Exponent adjustment

With this menu the Peukert exponent and the C.E.F. (Charge Efficiency Factor) can be in accordance with the type of battery installed (refer to chapter 11 for additional information) It is advisable to only change these setting if extended knowledge of the installed battery is available.



This menu can be entered by and holding the **Select** and **Set-up** buttons simultaneously for 5 seconds until the Set-up and Select LEDs flash.

Setting the Peukert exponent (A08)

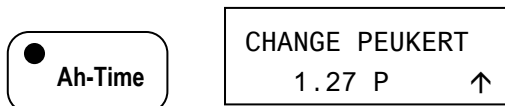

Press the **Ah-Time** button to enter the menu

With the **Set-up** button the value can be changed from 1.01 to 1.50. The factory default setting is 1.27.



Note: If the **Select** button is held for five seconds, the arrow in the right part of the display will change. If the arrow is pointing downwards (↓) the set value can be decreased by means of the **Set-up** button. If the arrow is pointing upwards (↑) the set value can be increased.

Setting the Charge efficiency factor (A09)

In the second the C.E.F. (Charge Efficiency Factor) can be changed. The C.E.F. is

recalculated automatically by the Masterlink MICC every time the battery makes a cycle. The calculated value is checked with the C.E.F. as stored in the memory of the Masterlink MICC. If the calculated value differs from the stored value, only 50% of the difference is compensated. This is to avoid the C.E.F. being changed too much by incorrect wrong settings or an incorrect calculation of the MICC. For an accurate calculation of the C.E.F., the Masterlink MICC needs approx. 6-10 cycles after power up.

If the C.E.F. of the battery is known, the C.E.F. can be set manually to give an accurate reading directly after power-up of the MICC, but even if the C.E.F. is set manually, the Masterlink MICC continues to calculate the C.E.F. and will automatically adjust it if necessary.

The C.E.F. can be set by means of the **Set-up** button between 70 and 90 %. The factory default is set at 90 %.

 Note: If the **Select** button is held for five seconds, the arrow in the right part of the display will change. If the arrow is pointing downwards (↓) the set value can be decreased by means of the **Set-up** button. If the arrow is pointing upwards (↑) the set value can be increased.

Return to users menu (A10)

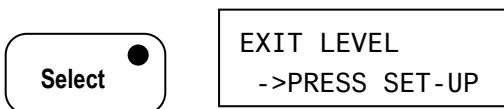

If this level is entered you can return to the user menu by means of the **Set-up** button.

10.3 Reset menu

The reset menu is used to reset the Masterlink MICC to its factory settings and to reset all historical data.



This menu can be entered by and holding the **Select** and **Set-up** buttons simultaneously for five seconds until the Set-up and Select LED's flash.

Return to the factory default settings (F06)

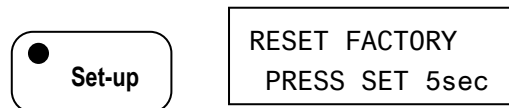

Now press the **Set-up** button to enter the menu

With the first level of the reset menu the MICC can be returned to the factory settings by holding the **Set-up** button for 5 seconds.

Resetting the historical data (F07)

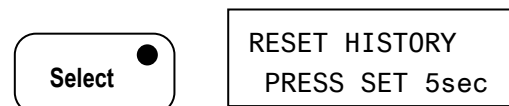

If new batteries are installed, the historical data of the old batteries needs to be erased to leave only historical data from the newly installed batteries. By holding the **Set-up** button for 5 seconds the old data will be erased and a new cycle for historical data will be started.

Return to users menu (F08)

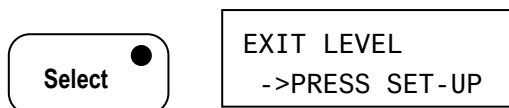

If this level is entered you can return to the user menu by means of the **Set-up** button.

11 ADDITIONAL INFORMATION

11.1 The Peukert Exponent

Deep cycle battery capacity is usually stated as a 20-hour discharge rate. A 100 Ah battery will provide 5A for 20 hours. At discharge rates above 5A the battery will not supply 100 Ah. For example: if you are drawing 100A out of the battery, it will last less than one half-hour. A scientist named Peukert discovered this in 1897. The Peukert-equation describes the effect of different discharging rates on the capacity of a battery. This effect is that with increasing discharge rate, the capacity of a battery decreases. Table 3 and the examples give you an idea of this effect and show how to estimate a value for the Peukert exponent in your situation. The Masterlink MICC uses Peukert's equation only for the calculation of Time Remaining. The number in the display (in Ah) is always the actual number of used Ah. This means that if you discharge the battery very fast, the Time Remaining can be zero before the meter indicates that the total capacity has been used.

Executing two discharge tests, one at a high and one at a low discharge rate, which are about the minimal and maximal discharge rate for your situation, enables you to calculate a value "n" for the Peukert exponent which fits best to your situation. The Masterlink MICC uses 1.27 as default value for "n", which will give good results for most batteries.

At low to moderate discharge rates, around the 20 hr discharge rate, the logarithmic effect of the Peukert equation is small. At lower discharge rates the effect is almost linear. For this reason battery manufacturers specify the capacity for a 20-hour discharge rate. Peukert's equation for battery capacity (Cp) reads:

$$C_p = I^n \cdot t$$

$$\text{where } n = \frac{\log t_2 - \log t_1}{\log I_1 - \log I_2}$$

By doing two discharge tests and knowing I1 and I2 (discharge current in one of the two tests), and t1 and t2 (time in hours of the two tests) you can calculate n. For this calculation you need a calculator that has a logarithmic function. You can use Table 3 for a better understanding of the effect of high discharge rates on the capacity of your batteries. You can use the table also to make an estimate of "n" of a battery after only one discharge test. The values in the table are based on a 100 Ah battery, but can be used for any capacity you like by applying the correct ratio capacity/current. See the examples given.

Discharge rates in A:

Charge	5	10	16.7	25	50	75	100	150	200	250	300	400	500
	100	100	100	100	100	100	100	100	100	100	100	100	100
	100	93	88	85	79	76	74	71	69	67	66	64	63
	100	87	78	72	63	58	55	51	48	46	44	42	40
	100	84	74	67	56	51	47	41	40	37	36	33	32
	100	81	69	62	50	44	41	36	33	31	30	27	25
	100	76	61	52	40	34	30	26	23	21	20	17	16
	100	71	55	45	32	26	22	18	16	14	13	11	10

Table 3: Percentage of available capacity from a 100 Ah battery at different discharge rates and different values for “n” (= Peukert exponent).

Example 1

Suppose you have a 200 Ah battery. Now discharge at a 50 A rate until the battery reaches 1.75 V per cell (10.5V for a 12 V battery). This would be equivalent to a discharge rate of 25 A for a 100 Ah battery. If the battery delivered 67% (134 Ah) the appropriate Peukert’s exponent would be 1.25.

Example 2

A 100 Ah battery with a Peukert’s exponent of 1.3 will deliver only 41 % of its capacity (41 Ah) when supplying a 100A load.

11.2 Time Remaining, CEF, & History.

The Charging Efficiency Factor (CEF) takes into account the fact that batteries are not 100 % efficient. You have to put in more energy than you take out. **All our meters learn the efficiency of the battery system.** The CEF is used to correct the rate at which Amp-hours are counted back during charging. The CEF is also displayed; a falling CEF is an indication of a failing battery. Additionally, the historic data available in the Meter includes the number battery cycles, and the deepest discharge.

12 GENERAL BATTERY INFORMATION

The lifetime and performance of batteries depend for a great deal on how they are cared for and used. Below we have listed some influences on the lifetime and some more information about charging and calculating the right capacity for your system.

Temperature

A high temperature is disastrous for the lifetime of your batteries. If they are regularly subjected to temperatures above 40°C you should relocate them or supply forced fresh air ventilation.

Discharge

Regularly discharging below 20 % of battery capacity has a negative effect on lifetime. For long life of the batteries it is best not to discharge the battery below 50 %.

Charging

Special care must be taken if wet type batteries are used. During charging they produce dangerous hydrogen gas. This means that special care must be taken for ventilation to avoid the danger of explosion.

To keep their capacity batteries must be charged fully regularly and the best way is to use a three step regulated charger. To adjust the charger according to the temperature of the battery will increase the lifetime of the battery significantly. Also a low voltage ripple will help to extend the lifetime of the battery.

Mastervolt therefore recommends the use of the Mastervolt Mass or IVO Smart chargers.

Charging a battery is simple if 230 V utility power is regularly available. However using a generator to charge the battery up to more than 85 % is not efficient. The reason for this is that the charging current is strongly reduced after reaching 80-85% of the battery capacity. A rule of thumb can be used that the last 20 % of charge of the battery will take 3-4 hours. To keep the generator time as short as possible batteries will not be charged up to the full 100 % if a generator is used to charge the batteries. Normally this will not harm the battery as long if they are brought back to a full 100 % at least every five to seven days.

Real available capacity

The battery capacity given by the manufacturer is based on the current the battery can deliver when fully discharged during 20 hours. Using the (not absolute) values for charging and discharging mentioned above (50 % and 100 %) means that about 50 % of the capacity as declared by the manufacturer is really available for use. If you often use a generator this can even be as low as 35 %

Choosing the best battery capacity for your situation

If you are going to decide about the battery capacity that you have to install it is good to keep the above mentioned 50 % in mind. If the batteries are often discharged at a higher rate than 5 % of the battery capacity (C 20 rate) as given by the manufacturer, it is also useful to take the Peukert effect into account. The 50 % rule and Peukert effect result both in larger battery sets as expected after simply counting factory specifications. However if you take both into account you will miss the often heard disappointment about the performance of batteries.

13 TROUBLE SHOOTING AND ERROR CODES

13.1 Trouble shooting

Problem	Possible cause	What to do
No display function	Error in the wiring	Check wiring for errors especially power supply (pin 1 and 2) (chapter 3.3 step 5)
No amp reading	Error in the wiring	Check wiring for errors especially between shunt and pin 3 and 4 (chapter 3.3 step 4)
No volt reading	Error in the wiring	Check wiring for errors especially voltage sense (pin 1, 2, 5 and 6) (chapter 3.3 step 6)
No voltage reading of secondary battery	Secondary battery not or wrongly connected	Check the wiring to pin 7 and 8. Connect wire between minus main battery and minus secondary battery (chapter 3.3 step 7)
Amp reading not accurate	Distortion on the shunt wiring	Replace wiring by twisted pair cable between the shunt and pin 3 and 4. (chapter 3.3 step 4) Rerun the wires and keep them away from equipment that might cause noise
Time remaining function indicating ----- during discharge	Shunt wiring reversed	Check installation drawing and correct the wiring. Pay extra attention to the distinction between battery side and system side (chapter 3.3)
Back light switches off after 15 seconds	Unit in sleep mode	Press one of the buttons or refer to chapter 9, step F01 to disable the sleep mode.
No accurate time remaining function	Wrong setting of the installed Ah	Refer to chapter 8, step A01 for the correct setting of the battery capacity.
Voltage /low Ah alarm not functioning correctly	Wrong setting of the parameters	Refer to chapter 7, for the correct setting of the parameters.
Voltage /low Ah alarm not functioning correctly	Testing alarm function is switched on	Switch off the Testing alarm function (chapter 10.1, step M06)
External voltage /low Ah alarm not functioning correctly	Wrong connection of relay contact	Connect the external relay to the correct pins (chapter 3.4)
Voltage /low Ah alarm not functioning	Alarm setting in the off position	Switch on the alarm function (chapter 10.1, step F02)
Voltage reading shows 0,00	Battery voltage below 7 volt	Charge the battery
Power sharing / Power support can not be adjusted.	Mass Combi setting not activated.	Check and if necessary activate the Mass Combi setting in the Masterlink MICC menu (see chapter 9 step F04). Check and if necessary activate the Power sharing / Power support function on the Mass Combi. See also the manual of the Mass Combi.

13.2 Error codes

The following error codes are displayed when the Masterlink MICC detects a problem. The display alternates between the selected monitoring function and the error code. The error code continues to flash until the error is corrected.

Code	Description	Action
E1	Battery Temperature error, the batteries are too warm to be charged safely.	The charger will stop charging until the battery temperature is within the safe margin. Make sure that the batteries are ventilated properly.
E2	DC error, automatic charger shut down due to too low or too high DC Voltage	DC system voltage has dropped below 10.5V (12V system), 21.0V (24V system), or has risen above 15.5V (12V system), 31.0V (24Vsystem)
E3	Short-circuit of the charger output.	Possible short-circuit on the output, The charge current will be reduced to a quarter of the maximum value.
E4	Charger is too hot, automatic charger shutdown due to too high temperature	The charger switches automatically on after it has cooled down sufficiently. Make sure that the charger is ventilated properly
E5	Charger switched off because of a battery sense error	The battery voltage sense wires are connected wrong or the charger has reached the maximum compensation value. The charger compensates the voltage loss with a maximum of 2,5V
E6	Inverter error.	The inverter is in overload, reduce load. Inverter temperature is too high, inverter will automatically switch off and on if temperature has dropped sufficiently. Make sure that the inverter is ventilated. DC supply voltage to high switch off charger .

The following error code is displayed when the Masterlink MICC detects a communication problem with the battery charger.

Code	Description	Action
NO COMM	Communication error with the battery charger. The battery charger is switched off or the AC-input is disconnected.	Switch on the battery charger or adjust the charger's DIP-switch correctly (refer to the charger's operation manual, "ContMon"; REMARK: When the ContMon function is enabled while the battery charger is switched off, energy is withdrawn from the battery connected to the battery charger.
NO COMM	Communication error with the battery charger. The battery charger is disconnected from the Masterlink MICC or connected by a wrong modular communication cable (RJ12, cross wired)	Check the wiring of the 6 pole modular communication cable (Chapter 3.2 and 3.3, step 9)

14 TECHNICAL DATA

Model	Masterlink MICC
Article number	70403105
Function of instrument	Battery monitor for 12 and 24 volt battery banks Remote control for a Mastervolt inverter and battery charger or Mass Combi
Manufacturer	Mastervolt Amsterdam the Netherlands
Voltage Measurement	7-35 volts (0.01 volt resolution)
Amperage Measurement	0-500 Amp 0.2A resolution (0 --42A) 2A resolution (42--500A)
Amp Hours Measurement	0-2000 Ah (1 Ah resolution)
Time remaining	0-255 hours (1-min resolution)
Supply voltage	9-35 Volt DC
Supply current	100mA(@12V) / 50mA(@24V) Normal operation 28mA(@12V) / 16mA(@24V) Sleep mode
Shunt	500 Amp / 50 mV supplied with the product
Accuracy	Voltage: $\pm 0,6\%$ ± 1 digit Current: $\pm 0,8\%$ of reading ± 1 digit
Dimensions	See chapter 15
Hole cut-out size	See chapter 15
Weight	250 gr.
Dept required	65 mm minimum

15 DIMENSIONS

Panel

Minimum required dimensions for installing (panel only): width x height x depth: 120 x 65 x 40mm

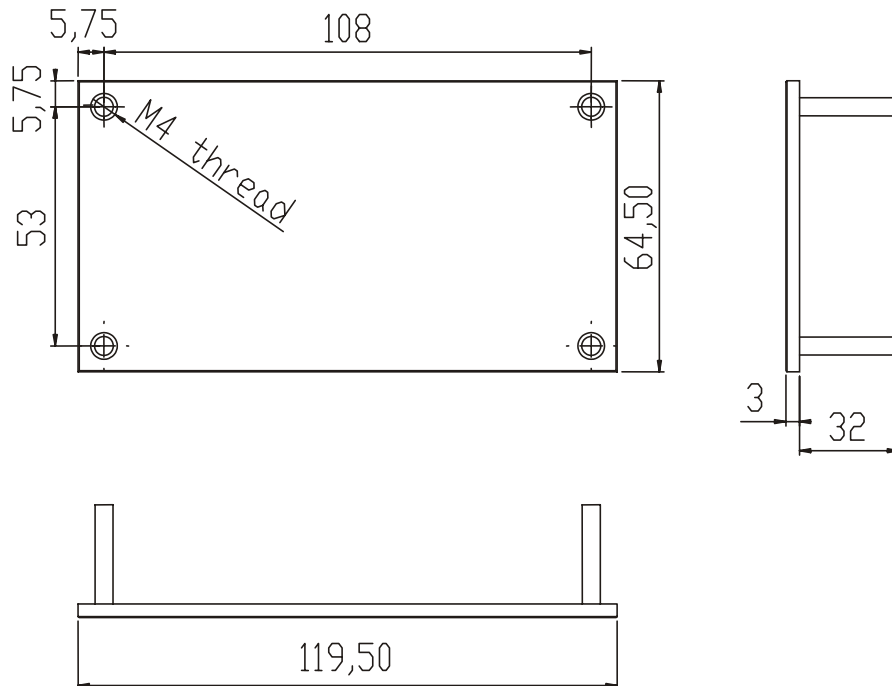

Grey mounting-box

Dimensions grey mounting-box: width x height x depth: 140 x 85 x 50mm

Dimensions for cut-out: width x height: 120 x 68mm (use the packing as mounting template)

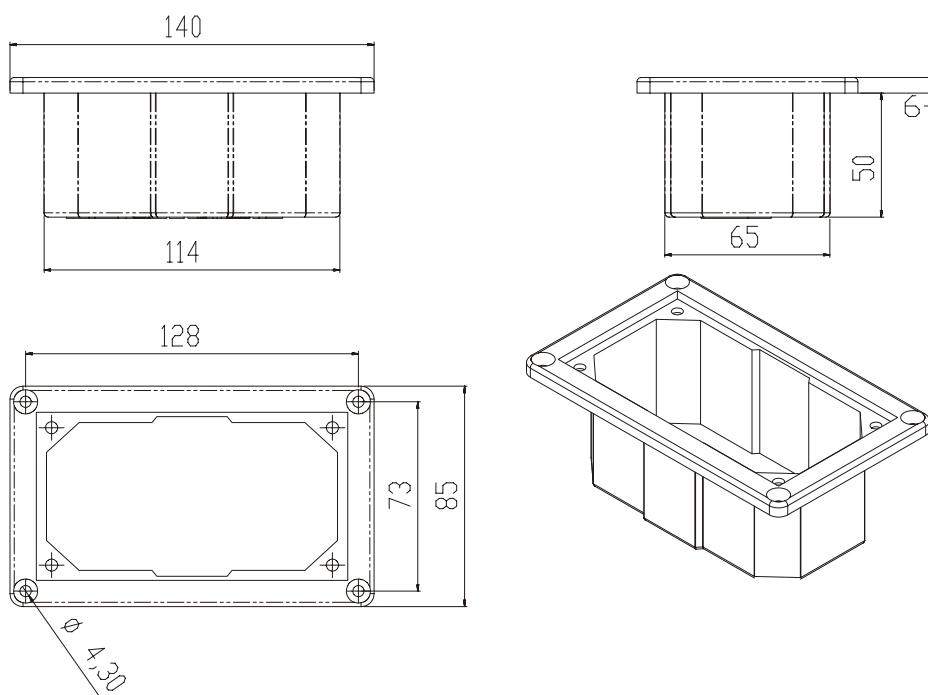

16 CE DECLARATION OF CONFIRMITY

Manufacturer: Mastervolt
Snijdersbergweg 93
1105 AN Amsterdam
The Netherlands

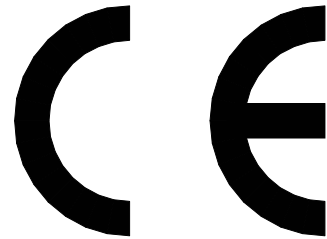

Herewith declares that:

Product: Masterlink MICC

Is in conformity with the following provisions of the EC:

EMC directive EMC 89/336/EEG and amendments 92/31/EEC and 93/68/EEC.

The following harmonized standards have been applied:

Generic emission standard: EN 50081-1:1992

Generic Immunity standard: EN 50082-1:1997

Safety directive 73/23/EEC and amendment 93/68/EEC, with the following standard:

Low voltage standard: EN 60950: 2000

Amsterdam,

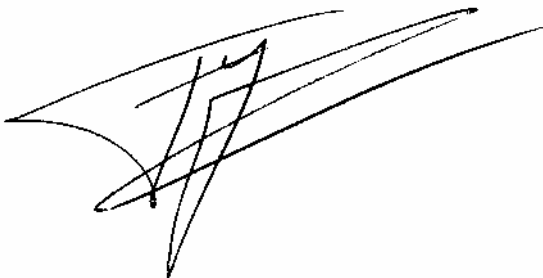

Dr F.J. ter Heide,
General Manager MASTERVOLT



Snijdersbergweg 93, 1105 AN Amsterdam, The Netherlands

Tel : + 31-20-3422100

Fax : + 31-20-6971006

Email : info@mastervolt.com